



COMUNE DI BADESI  
Provincia di Olbia-Tempio

PIANO DI UTILIZZO DEL LITORALE

PROGETTAZIONE  
R.T.P. SMALL ARCHITECTS  
Dott. Ing. Pier Franco Azzena

IL SINDACO:  
Per. Agr. Anton Pietro Stangoni

RESPONSABILE DEL PROCEDIMENTO:  
Ing. Antonio Giovanni Mannu

GENNAIO 2010  
rev. 4  
scale VARIE

TAV. 08.2

ELABORATI TECNICI  
Manufatti di supporto alla balneazione: tipologia 2,  
tipologia 2a, tipologia 6, tipologia 7

Tipologia 2 - Punto di ristoro, chiosco bar

Individuazione aree fruibilità interna Scala 1:200

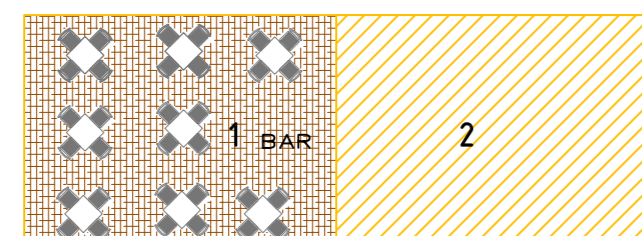

LEGENDA

- 1 - zona ombreggio punto di ristoro 50 mq
- 2 - Area coperta 50 mq
  - 2a chiosco bar
  - 2b servizi igienici (di cui uno accessibile da portatori di handicap)
  - 2c passerella in legno

Prospetto laterale - scala 1:100

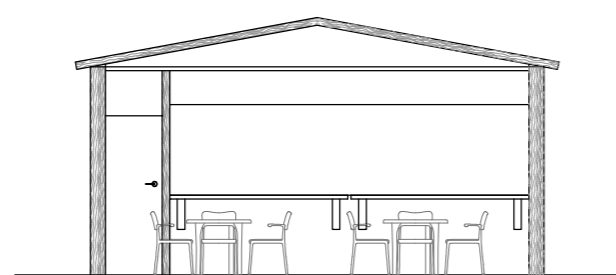

Pianta - scala 1:100

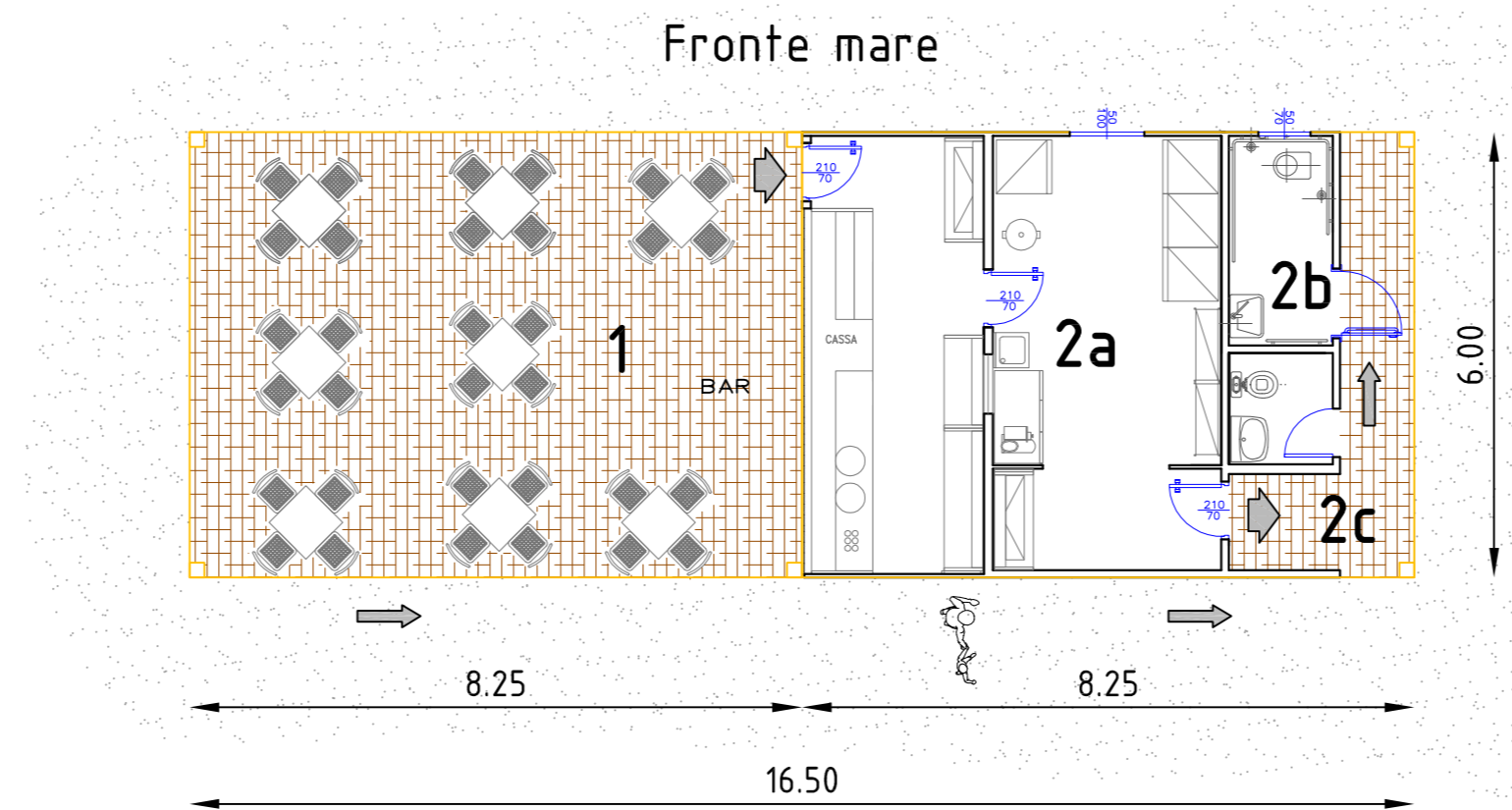

Prospetto frontale - scala 1:100

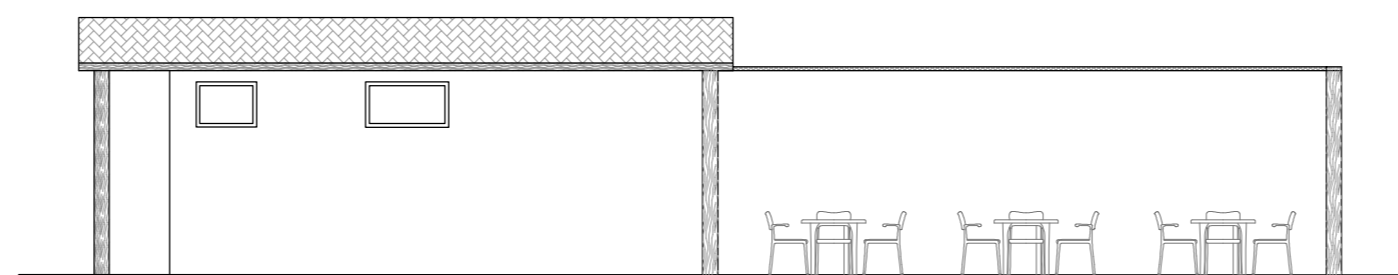

Tipologia 2a - Chiosco bar

Individuazione aree

Scala 1:200

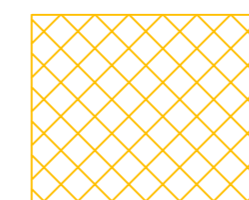

Area coperta  
max 30 mq

Pianta - scala 1:100

Fronte mare

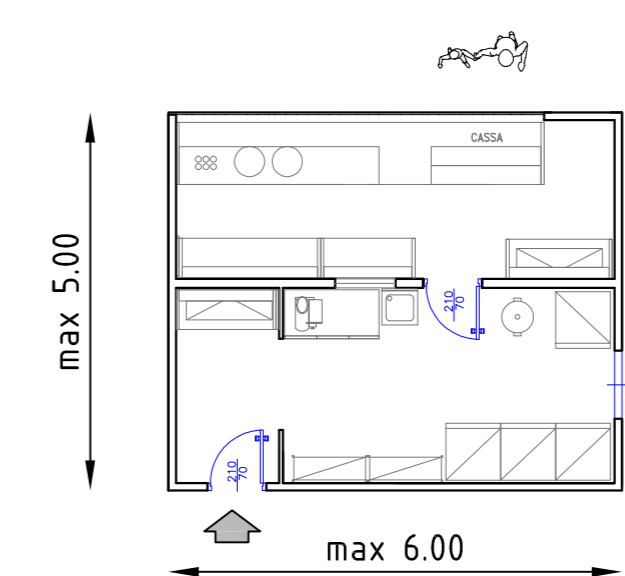

Prospetto frontale - scala 1:100

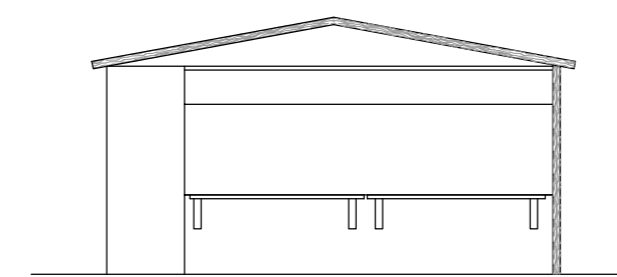

Prospetto laterale - scala 1:100

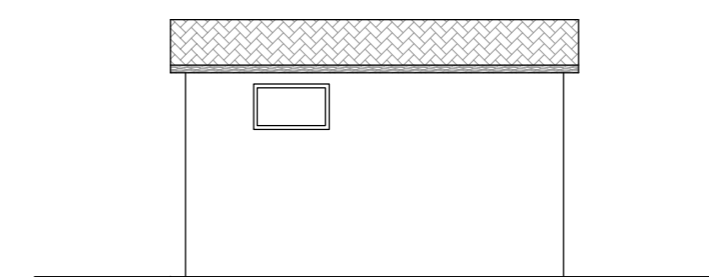

Tipologia 6 - Scuola velica

(solo locale, esclusa area di servizio)

Tipologia 7 - Locale commerciale

Individuazione aree

Scala 1:200



Area coperta  
max 30 mq

Pianta - scala 1:100

Fronte mare

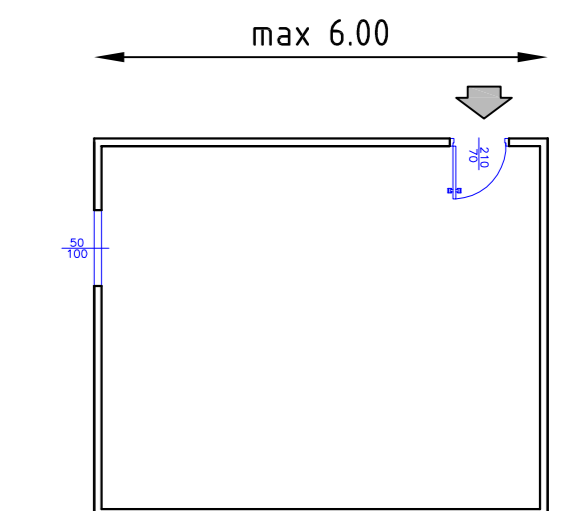

Prospetto frontale - scala 1:100

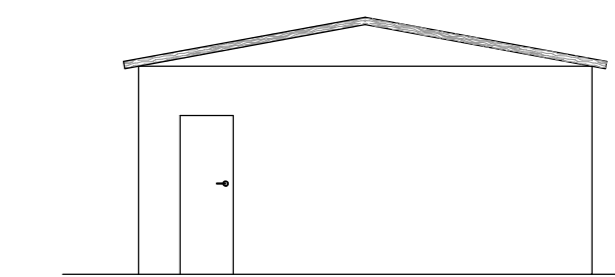

Prospetto laterale - scala 1:100

